

MIRANIT

mosdók, mosdópultok, sormosdók

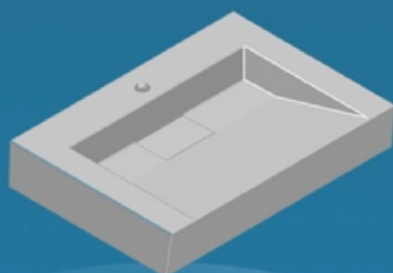

DE0301

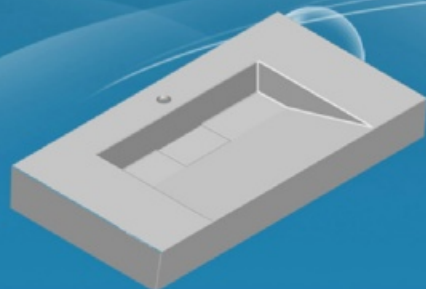
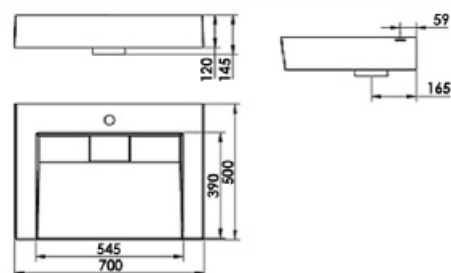

DE0302

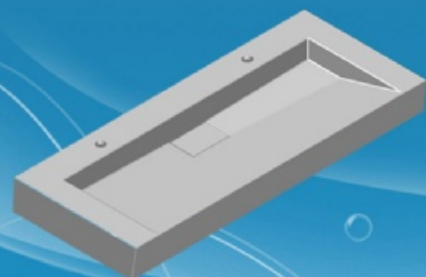
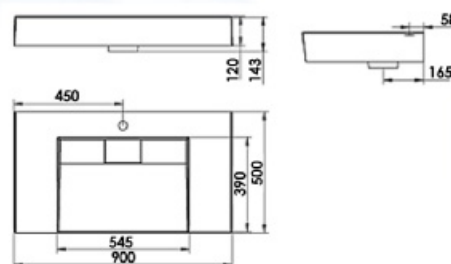

DE0303

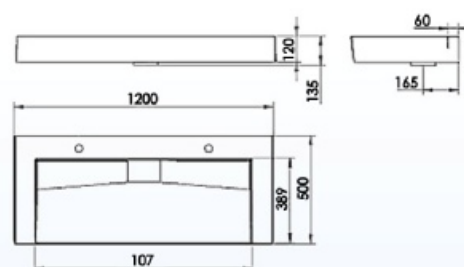

DE0602

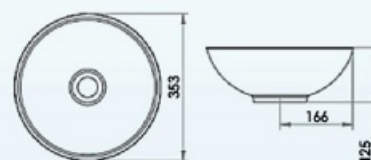

DE0303

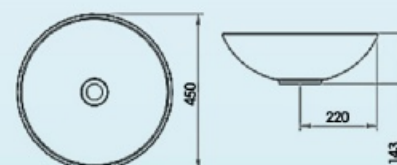



DE0401

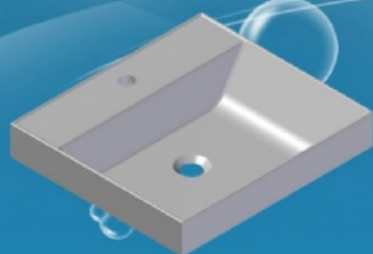
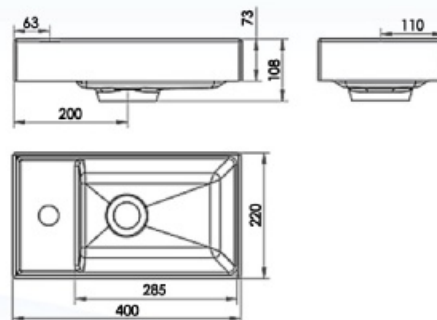

DE0402

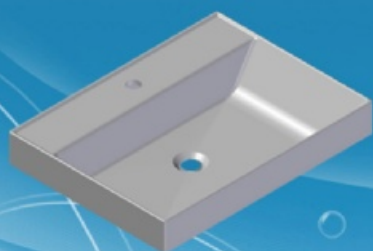
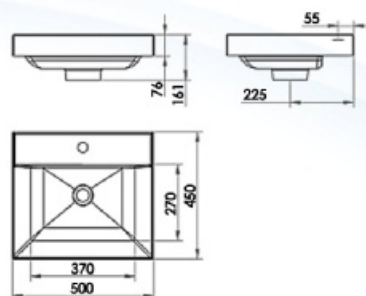

DE0403

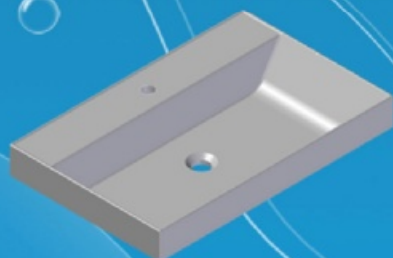
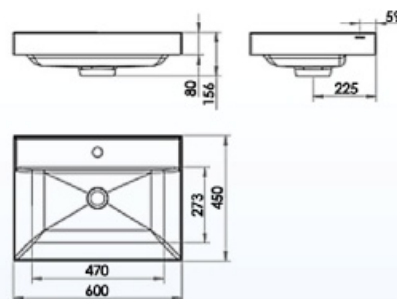

DE0404

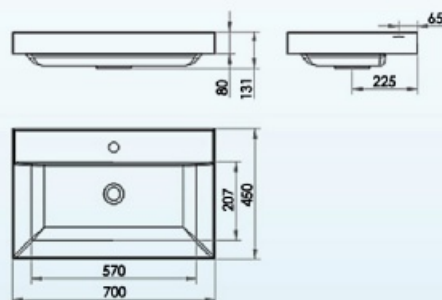

DE0405

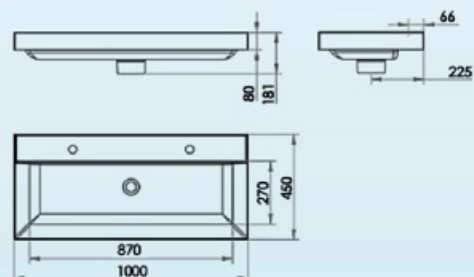

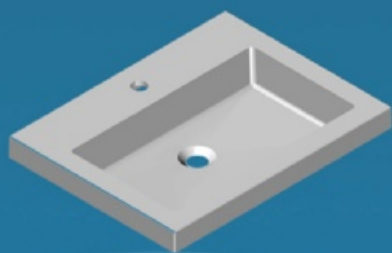

DE0101

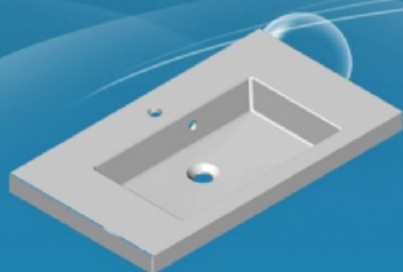
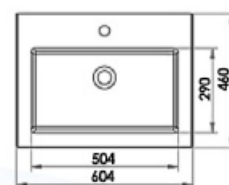
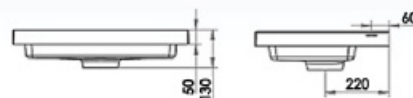

DE0111

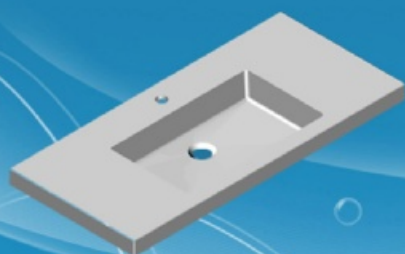
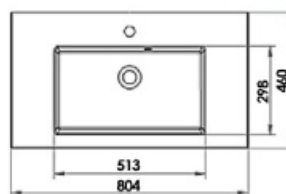
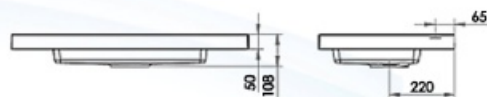

DE0112

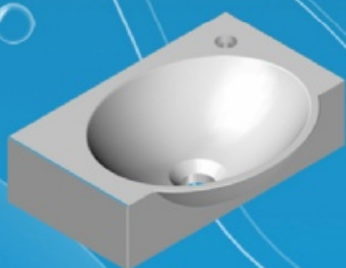
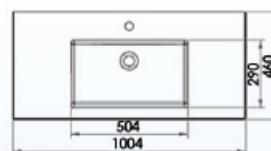
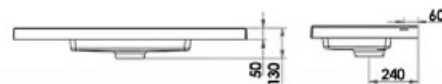

DE0501

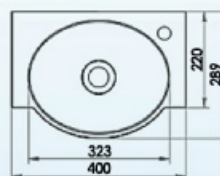
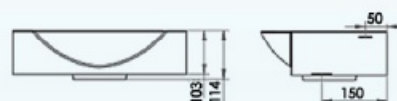

DE0601

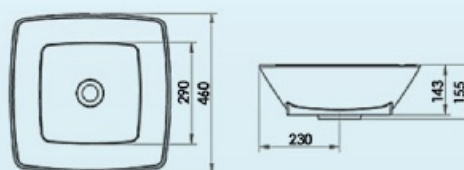

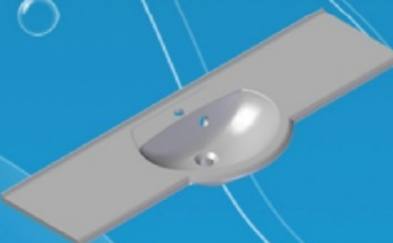
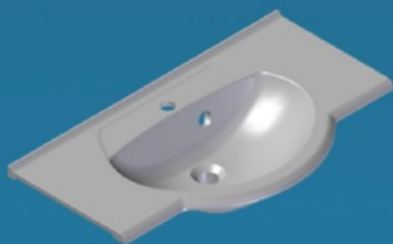

DE0201

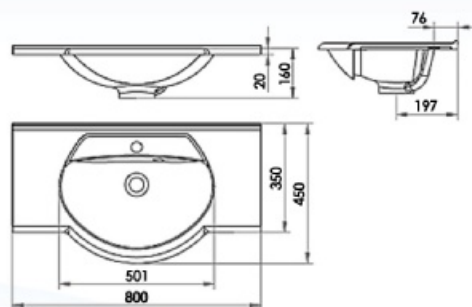

DE0202

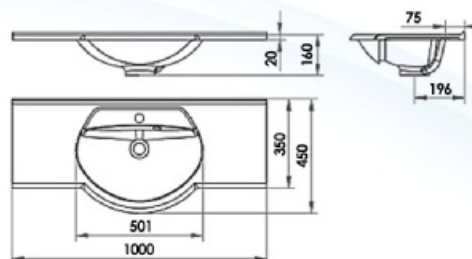

DE0203

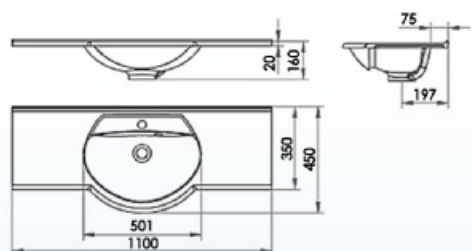

DE0204

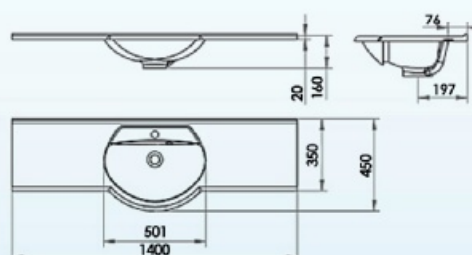

DE0701

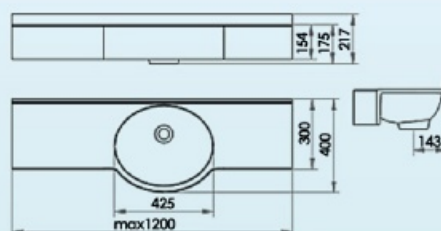

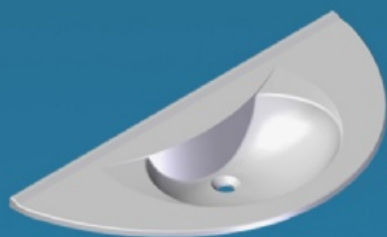

DE0801

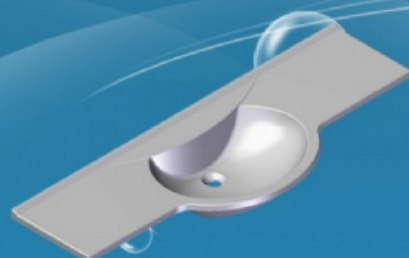
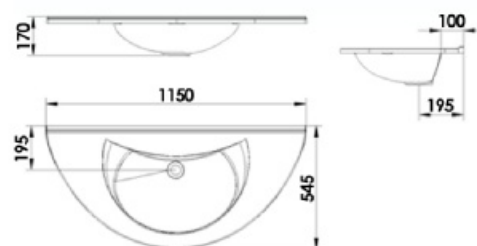

DE0901

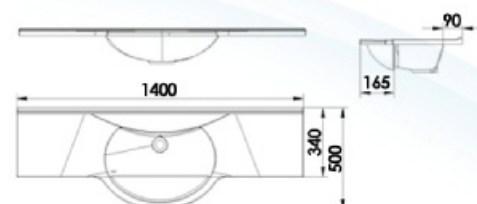

DE1001

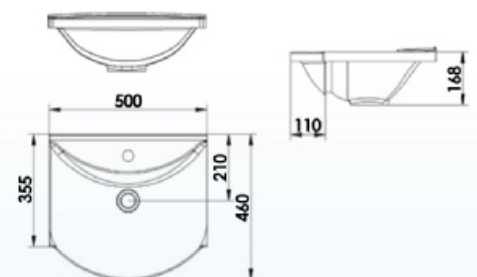

KÜLÖNBÖZŐ ANYAGÚ MOSDÓK ÖSSZEHASONLÍTÓ TÁBLÁZATA

| | Porcelán mosdó | Rozsdamentes acél mosdó | Miranit mosdó |
|---|--|--|--|
| Alapanyag | kaolin, földpát, kvarc | KO33, húzott rozsdamentes acéllemez | Poliészter gyanta + márvány/gránitörlemény |
| Szín | Csak fehér színben kapható | Fémszínű | A fehér mellett több színben is kapható |
| Tartósság | Tartós használat esetén a zománc megfakul. Javítást követően könnyen foltosodik. | Tartós használat esetén a felület karcosodik, foltosodik, nehéz tisztítani. | A polírozott felület ütés, súrlódás és kopásálló, valamint jó lág- és saválló képességű. |
| Szennyeződéssel szembeni ellenállóképeség | A szennyeződés könnyen megtapad a felületen, problémás tisztítani. | A szennyeződés (különösen tea és kávé) megtapad felületen, problémás tisztítani. | Könnyen tisztítható, higiénikus |
| Terhelhetőség | ALACSONY Ha leesik, könnyen törik | KÖZEPES Terhelés hatására változhat az alak | MAGAS Terhelésnek jól ellenáll, de nem rugalmas |
| Egyéb | Hideg tapintású Szilánkosan törik Nehezen javítható | Hideg tapintású Nehezen javítható Zajos (vízfolyástól) | Meleg tapintású Hőnek jól ellenáll Egyszerűen és gyorsan javítható |

VÁLASZTHATÓ SZÍNEK:

Gelcoat változat - basic

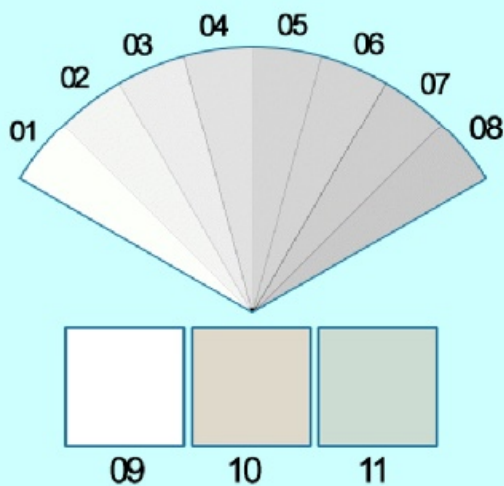

Gelcoat változat - gránit hatású (magas fényű)

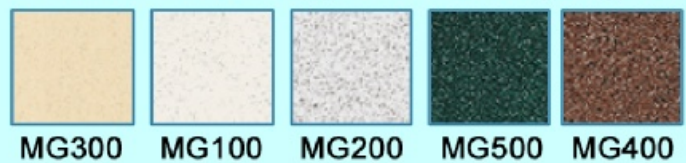

Solid Surface változat (matt vagy fényes)

